

M	1				CPCD30
	2				
	3			kg	3000
	4			mm	500
	5			kg	4260
	6	,	/	kg	6450/1680
	7	,	/	kg	810/2580
	8				
	9		/		2/2
	10			mm	1760
	11				28 × 9-15-14PR
	12				6.50 -10-10PR
	13		/	mm	1000/980
	14			mm	3000
	15			mm	145
	16			mm	2110
	17			mm	4146
	18		/	deg	6° / 12°
	19			mm	1100
	20		/	mm	272 / 1072
	21	x	x	mm	50x 122 x 1070
	22			mm	2720
	23			mm	1225
	24			mm	2150
	25			mm	2400
	26			mm	475
	27			mm	2190
	28			mm	135
	29			mm	140
	30		/	km/h	18.5/19
	31		/	mm/s	455/475
	32		/	mm/s	460/480
	33			N	16475
	34		/	%	18 / 20
	35				/ -
	36				/
	37				Xinchai
	38				C490BPG
	39				CHN Stage II
	40				4
	41			L	2.67
	42			kw/rpm	40/2650
	43			N.m/rpm	160/1800

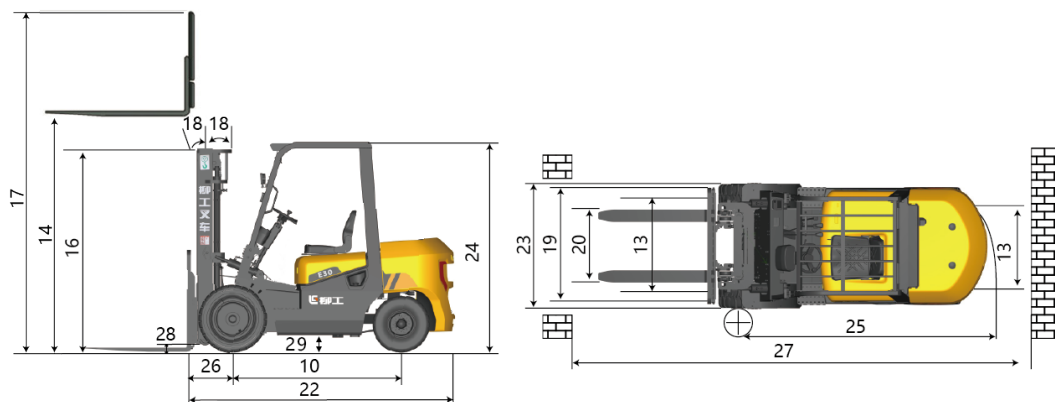

LIUGONG

E



Xinchai

3000kg
40 kW

CPCD30

E